



SmokeCloak *EASY* 600/1100

INSTALLATION AND OPERATING INSTRUCTION



Every effort has been made to ensure that the contents of this manual are correct. MSS Professional A/S does not accept any liability for loss or damage caused or alleged to be caused directly or indirectly by this manual. The contents of the manual may be subject to change without notice. MSS Professional A/S makes no warranty of any kind with regards to this material.

© 2012 MSS Professional

Reproduction in any matter whatsoever without the written permission of MSS Professional A/S is strictly forbidden.

READ AND SAVE THESE INSTRUCTIONS

MSS Professional A/S

Agerhatten 25

DK - 5220 Odense SØ

Danmark

Telefon: +45 6473 1407

smokecloak@mssprofessional.com

www.smokecloak.com

Manual

SmokeCloak EASY range



Please read this manual carefully before attempting to install a Smokecloak easy.

Conventions

The following symbols are used in this manual to help you install the SmokeCloak system correctly and safely.



Note

Gives useful advice or suggestions to enhance the performance of the SmokeCloak system.



Important

Indicates important information that is critical for the correct use of your products and must always be read carefully.



It is essential that only genuine SmokeCloak fluid is used. Damage to the equipment and possible health hazard is likely if incorrect fluid is used. The warranty on all of the equipment will also be void.

Under no circumstances should the on board power supplies of the SmokeCloak "12v output" be linked to any other 3rd party equipment e.g. alarm panels, additional power supplies, etc. as this could cause unexpected faults within the machines.

In areas fitted with equipment generating high levels of electrical interference, screened alarm cable may be required to ensure correct operation of the EASY unit.

Contents

- 1. IN THE BOX..... 6
- 2. QUICK START GUIDE 6
- 3. SPECIFICATIONS 8
- 4. MACHINE LAYOUT 9
- 5. INSTALLATION..... 10
- 6. DIRECTING THE NOZZLE 11
- 7. FLUID..... 12
- 8. PRIMING THE MACHINE 14
- 9. BATTERIES 15
- 10. WIRING UP THE MACHINE 18
- 11. INTERFACE BOARD..... 19
- 12. CONNECTION DETAILS..... 20
- 13. SETTING THE ACTIVATIONS TIME 27
- 14. PREPARATION FOR FINAL TEST 28
- 15. MAINTENANCE 29
- 16. TIMERS..... 30
- 17. ACCESSORIES 31
 - Fluid FL600..... 31
 - Strobe IPL3000 32
 - Sounder IPA 117..... 33
 - Voice Module..... 34
 - Batteries 35

1. In The Box

Before attempting to install the machine it is advisable to ensure that you have all the required components. Upon opening your SmokeCloak EASY box you should find:

x1 off SmokeCloak EASY

Check serial labels to ensure the correct voltage.

x1 off Manual pack

Warning stickers

CD ROM contains the Manual in the available languages.

2. Quick Start Guide

To quickly prepare and fire your unit, the following steps should be taken. For more detail on anything below, see the full guide provided.

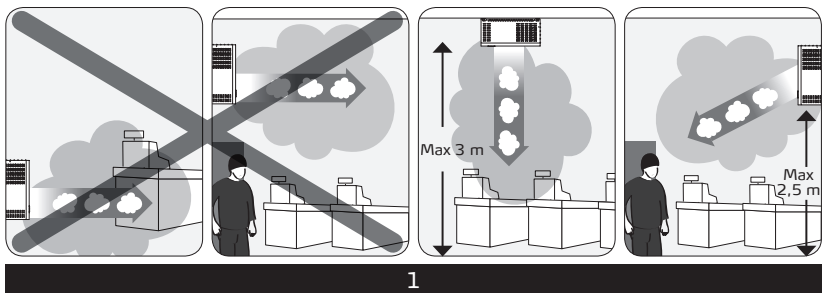

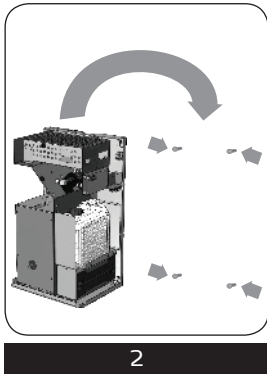

2

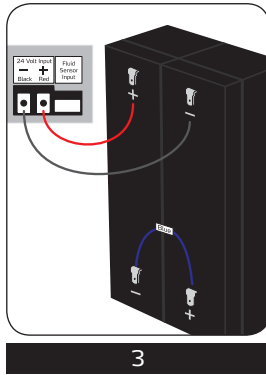

3

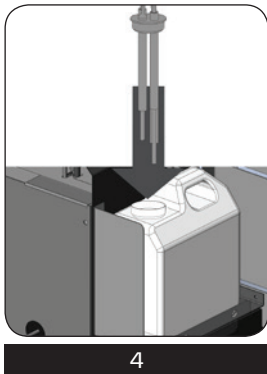

4

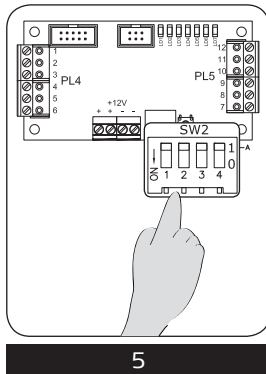

5

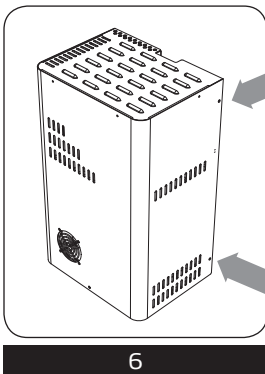

6

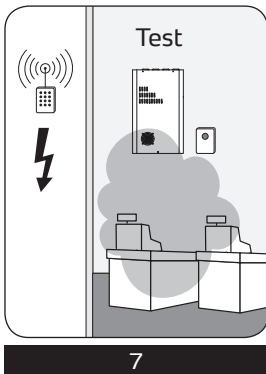

7



8

3. Specification

	EASY 600	EASY 1100
Dimensions	252 mm wide x 193 mm deep x 418 mm high	327mm wide x 193mm deep x 418mm high
Installation weight	10,6 kg	13,8 kg
Colour	white RAL 9016	white RAL 9016
Fluid	1,0 litre fluid refill system	1,0 litre fluid refill system
Electricity	200 - 250V & 110V	200 - 250 V
Power consumption	1500watt @ 230 Volt / 1050 watt @ 110 V	2100 watt @ 230 V
Average power consumption	75W	140W
Reaction time	0,1 seconds	0,1 seconds
Output	30 sec.: 420 m ³ (210*) 60 sec.: 630 m ³ (315*)	30 sec.: 804 m ³ (402*) 60 sec.: 1284 m ³ (642*)
Pulse Function	Programmable via Dip switch	Programmable via Dip switch
Heat up time (ready)	9 min.	9 min.
Number of output nozzles	1	2
Tested and approved in accordance with EN 50131-8:	Yes	Yes

*M3 according to current EU standard EN 50131-8

Weight (Install)

Represents the weight of the machine, without the covers on, and without the batteries or any fluid installed.

Weight (Shipped)

Represents the weight of the machine packed within its box

Weight (Hanging)

Represents the weight of the machine, in its armed state hanging on a wall. That includes covers, Batteries and a full container of fluid.

Heat-up time (rdy)

The figure given is a time to 'ready' state at an ambient temperature of 20°C

Heat-up time (full)

The figure given is a time to full temperature at an ambient temperature of 20°C

4. Machine Layout

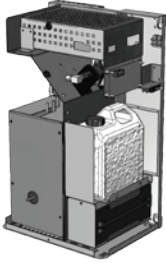

Internal isometric



External front

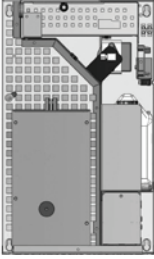

Internal

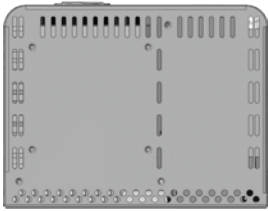

Bottom



Top

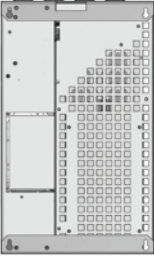

Rear



L/H side



R/H side



Front

5. Installation

5.1 Position

The SmokeCloak EASY can be installed vertically for wall mounting, or alternatively mounted horizontally for ceiling installations.



This equipment should only be installed and connected to the supply by a suitably skilled and competent person.

This apparatus must be earthed. Connections are made to a plug-in terminal block. The SmokeCloak should be connected to a standard 13 amp fused spur.

Flexible mains cables must have a minimum cross-section area of 1.25 mm² (and must be BASEC approved in the UK). Ensure that the protective earth conductor is made longer than the live and neutral conductors, and that the cable clamp grips both the sheath and insulation.



Wall mounting: It is not recommended to install the machine in excess of 2.5 m high, otherwise the smoke coverage near the floor may be compromised.

Horizontal mounting: Ensure the machine is no more than 3 m above the floor, otherwise smoke dispersal may be compromised.



In areas fitted with equipment generating high levels of electrical interference, screened alarm cable may be required to ensure correct operation of the EASY unit.

6. Directing the nozzle(s) correctly

The nozzle(s) can carefully be bent by using a screwdriver.

Note the EASY1100 has two output nozzles so it is possible for the fog to travel in two different directions.



Take great caution when directing the nozzle, it becomes extremely hot as the machine heats up. Do not attempt to handle the nozzle once the machine has heated up to temperature.

7. Fluid

FL600 fluid is used to generate the vapour cloud. This glycol based fluid is made to a special formula, which is designed to produce 40% obscuration of light at 40 cm with minimum condensation.

7.1 Installing the Fluid Bottle

Your SmokeCloak EASY product will be supplied with a full fluid container installed. It will arrive with a sealed travel cap installed. The following steps should be taken in order to correctly install the fluid bottle and the fluid sensing unit.

1. Remove the fluid bottle from the machine,
2. Slide the fluid sensor assembly inside the bottle – screw down the cap tightly to create a seal.
3. The bottle can then be slid back into position within the machine.
4. It is recommended that following any installation of the bottle a short test fire is carried out to ensure the fluid line has been correctly re-installed and to re-prime the fluid feed lines.

It is essential that only genuine SmokeCloak fluid is used. Damage to the equipment and a possible health hazard is likely if incorrect fluid is used. The warranty on all of the equipment will also be void



7.2 Changing the Fluid

As part of the maintenance of the SmokeCloak EASY it is essential that the fluid is replaced annually to ensure that the quality of the effect produced is maintained at the desired level.

In order to change the fluid follow the same instructions in the previous section for installing the fluid bottle, once removed.

Discard the empty fluid container and replace with a new full bottle of fluid.

The fluid should be changed (not topped up) at least once a year. Do not mix batches of fluid. (Batch number is printed on the front of the bottle).



Take care not to overfill the bottle
– it could potentially lead to electric shock.

8. Priming the machine

Following either the initial installation of the fluid bottle or following changing of the bottle it is essential that a short test firing is carried out to ensure that the fluid feed pipes are correctly primed. Failure to follow this procedure will lead to delayed response time the first time the machine is fired following the service or, more significantly, a failure to observe a connection fault incurred during the installation or re-installation of the fluid bottle.

During the test firing, observe the output to ensure the level is satisfactory before leaving the machine.

If the level appears to be below what would normally be expected of the machine, repeat the test process. If after 3 test cycles the output still appears to be below the 'regular' level of effect check the following:

1. The fluid cap was correctly re-engaged into the bottle, that the fluid feed pipe wasn't trapped in any way, and that the cap was firmly screwed back into position.
2. If there still appears to be a problem contact your supplier.

9. Batteries

9.1 To install the batteries:

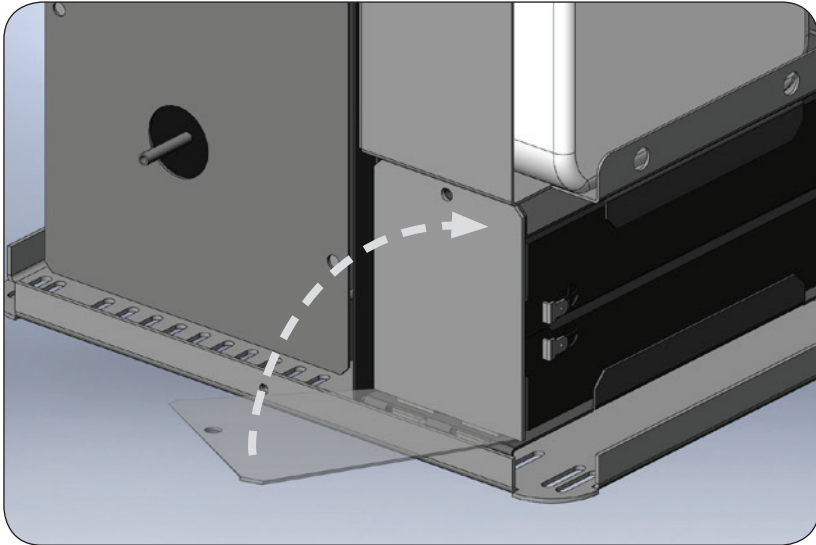

Once the batteries are installed within the bracket provided they must then be wired together in series and connected to the power board.

Follow the instructions below – The battery loom provided should be used. It will contain a single blue wire used for linking the batteries in series and in addition a red and a black wire for connecting the wires back to the power board.

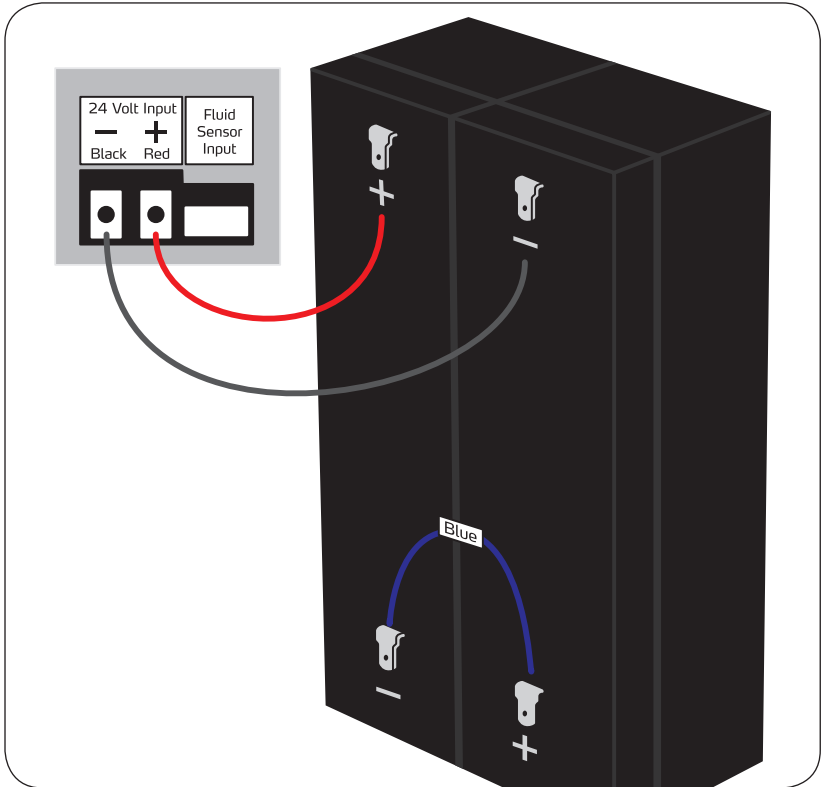

The red wire should be terminated at PL22 on the power board and the black wire at PL21. The terminals labeled + with the red wire, and - with the black wire.

The battery backup system provides power for the control electronics and pumps when mains electricity is removed.

The standard backup system does not provide power for the heater. The insulation is designed to retain sufficient heat in the aluminium heat exchanger assembly.



The SmokeCloak must have the batteries installed, even when operating from the mains,

The battery backup system requires 24 V d.c. - it is necessary to fit two 12 V 2.1 Ah batteries in series in the SmokeCloak. Do not use larger than 2.1 Ah capacity batteries to prevent fuse failure due to excessive charging current.

Please note that the temperature inside the SmokeCloak can exceed 40 degrees depending on the ambient temperature - the batteries must be able to withstand this temperature under charging.

Take care with polarity. The SmokeCloak is protected with an auto-reset fuse to safeguard against reverse polarity connection of the batteries. The LEDs on the interface board will give indication of correctly installed fluid and batteries.



PCB damage due to incorrectly fitted/sized batteries is not covered under warranty.

MSS Professional strongly recommends that Fiamm 2.1 Ah batteries or similar quality are fitted. These can be purchased from MSS through your distributor.

10. Wiring up the Machine

The mains power and low voltage control signals are clamped to the installation bracket using the cable clamps provided. The cables should be routed through the cable guide provided on the back face of the bracket, then fed through the cable clamps and terminated with the supplied plugs. Lead lengths between the clamps and plugs should be a maximum of 30 cm.

10.1 Wiring the mains feed

Remove the mains plug from the electronics module and fit to the flexible mains cable that has been fed through the cable grommets. Plug mains lead back into motherboard.

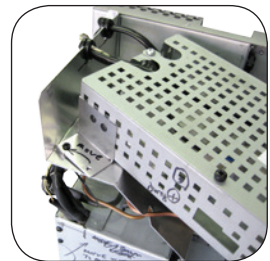
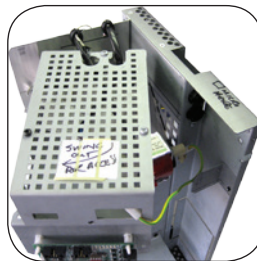
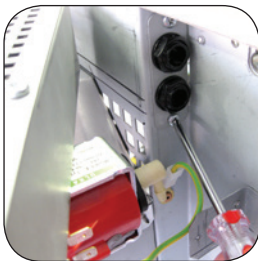
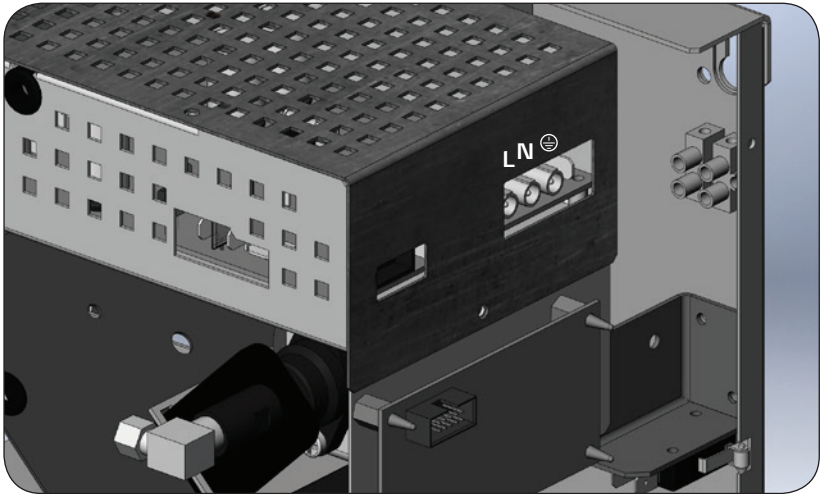

11. Interface board

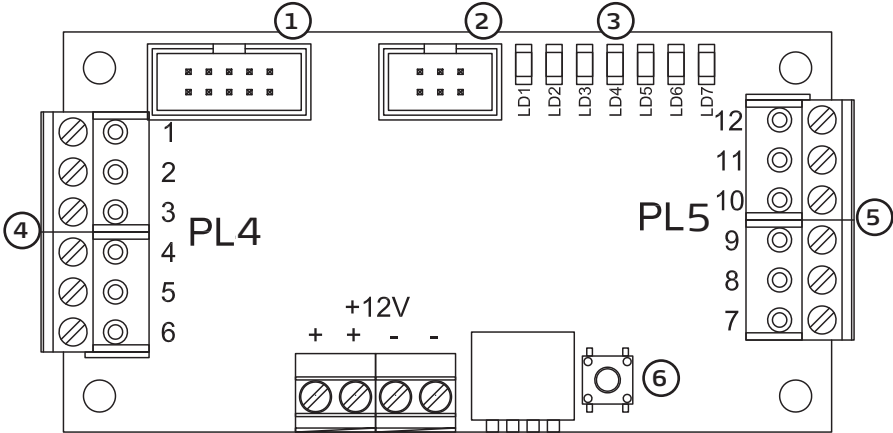

1. SPI connection
2. Programming socket
3. LED output
4. PL4
5. PL5
6. Switch 1 / Test button - 10 sec. activation



- The button needs to be held for approx. 4 seconds prior to fog production. This is to prevent accidental activations.
- The fog production can be stopped once started via the test button by pressing it again during the 10 sec output.
- The PIR input can prevent the unit from activating via the Test button. Ensure it is disconnected when using the test button.

11.1 Status LEDs

LEDS	LD 1	Battery (on - ok)
	LD 2	System ready (on - ready)
	LD 3	Heater (on - heating)
	LD 4	No fluid (on ok, off fault)
	LD 5	Low fluid (on ok, off fault)
	LD 6	System (on - ok)
	LD 7	System active (off - active)

- * LED 2 flashing = Temperature fault
- * Mains fail Indicated by LED 6 going off with no other fault Indicated.
- * Battery fault will cause the LED 5 to go off as well due to the nature of fault output.

12. Connection Details

12.2 Interface Board Connections

PL 4	Terminal 1 } Terminal 2 }	Pir + Pir -
	Terminal 3 } Terminal 4 }	Set + Set -
	Terminal 5 } Terminal 6 }	Trigger + Trigger -
	Terminal 7 } Terminal 8 }	Normally closed (open when system active) System active (default). Follows Backstop timer.
	Terminal 9 } Terminal 10 }	Normally closed (open in fault condition) Non critical fault
	Terminal 11 } Terminal 12 }	Normally closed (open in fault condition) System fault



Under no circumstances should the on board power supplies of the SmokeCloak (- 12v) be linked to any other 3rd party equipment e.g. alarm panels, additional power supplies, etc. as this could cause unexpected faults within the machines. This supply may drop to 0 V while the machine is still operational. Do not use this output for any purpose which may be affected by this power loss.



In areas fitted with equipment generating high levels of electrical interference, screened alarm cable may be required to ensure correct operation of the EASY unit.

12.3 Typical Cables required:

Connections between the SmokeCloak and the alarm panel 7 are made to the interface board via two 6-way plug-in connectors. LEDs also found on the interface board indicate information concerning the status of the SmokeCloak.

1 cable with up to 16-cores

- 1 pair for critical fault
- 1 pair for tamper
- 1 pair for non critical fault
- 1 pair for set
- 1 pair for trigger

12.4 Power

12.4.1 12 V powersupply, +/- 12v

This output is for supplying power to external devices such as, Cloak sensor, PIR sensor, or other verification sensor. Maximum current draw from this powersupply is 250 mA

12.5 Digital Inputs

12.6 12 V Inputs

The inputs to the SmokeCloak are optoisolated and can be directly connected to transistorised outputs from alarm panels (2mA draw), the connections are polarity conscious and care should be taken. The inputs require between 5 V – 12 V applied to operate correctly (normal power supply tolerances apply).

12.6.1 Verification sensor, terminal 1 & 2

PIRs or similar can be connected to terminals 1 and 2. The power for active devices (250 mA max) is taken from (+12 V) (0 V).

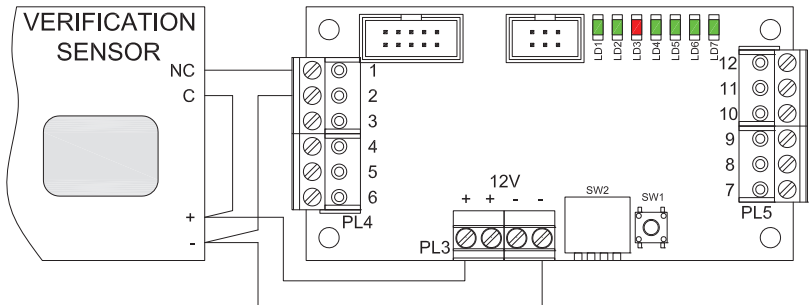

SmokeCloak Easy interface to alarm panel wiring
VERIFICATION SENSOR CONNECTION 3257-A

This input does not trigger the SmokeCloak, but holds off its activation despite an alarm trigger until the verification loop detects an intruder. The backstop timer is also inhibited until smoke is produced.



12.6.2 Set, terminal 3 & 4

Description:

Set signal should come from the alarm panel when the user sets the alarm – e.g when leaving the premises after work.

Unset is the opposite of the set, and therefore the alarm panel should remove the set signal when the alarm is turned off.

It is only possible to trigger the SmokeCloak EASY once after the alarm is set, which means that if the EASY is required to trigger more than once (from the Alarm Panel) the SmokeCloak EASY will require an unset signal before it will trigger again.

Activation:

This function is activated by applying 12 V (default) across terminal 3+ve and 4-ve.

12.6.3 Trigger, terminal 5 & 6

Description:

The trigger signal should come from the alarm panel when the alarm is triggered.

Due to that the SmokeCloak EASY will fire if:

- There is a “SET” signal present.
- It has not been triggered before with the current “SET” signal.
- The verification sensor is “activated” or NO verification sensor connected.

The trigger signal must be set continuously from the initial alarm, until the backstop timer is timed out.



Activation:

This function is activated by applying 12 V (default) across terminal 5+ve and 6-ve.

Examples of connections of the set and trigger signal to the alarm panel. Use the appropriate diagram below to interface the SmokeCloak to your alarm panel:

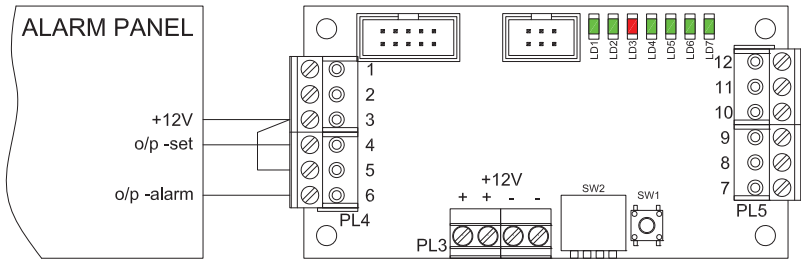

**SmokeCloak Easy interface to alarm panel wiring
NEGATIVE SET AND NEGATIVE TRIGGER** 3255-A

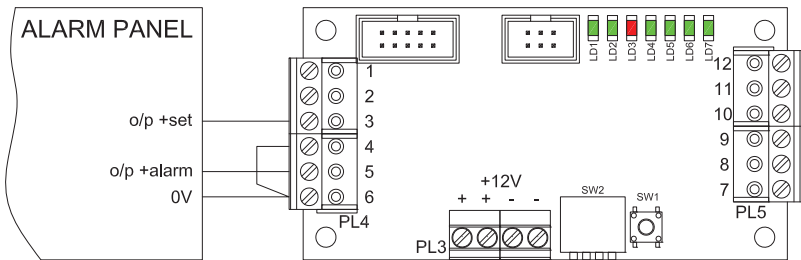

**SmokeCloak Easy interface to alarm panel wiring
POSITIVE SET AND POSITIVE TRIGGER** 3255-A

DISCLAIMER: Actual alarm panels may vary from those illustrated and MSS PROFESSIONAL cannot be held responsible for faults due to incorrect installations.

12.7 Outputs

The fault outputs are “clean” 150 mA, 60 V DC solid state relay contacts PL5 (terminals 7-12).

During the day when the alarm panel is de-activated, it is important that SmokeCloak cannot produce smoke, so the pump(s) are only connected to the control electronics when the panel is set or armed.



It is essential that these fault circuits should only be connected to either a logged local warning circuit (i.e. technical or plant monitor) or via the communicator to the central station, so that, in the event of a fault, a full alarm condition will not occur!

If the machine enters a low power mode (when the mains are removed for a long period) the fault relays will become open circuit.

Always ensure that this will not cause a problem within the installation.

It is not desirable to have a full alarm condition and then a SmokeCloak activation just because of a fault condition.

If the alarm panel is not capable of supporting local alarm only, for monitoring these circuits, then consider using a spare communicator line to central station. As a last resort a buzzer or LED can be used as a warning device. If in doubt please contact your supplier for advice



It is important that in the event of a fault being displayed you contact your installation engineer.

Failure to do so could lead to risk of fire or electric shock.

12.7.1 Activation Relay (terminals 7 and 8)

Terminals 7 and 8 are normally closed

Description:

This relay reflects the time of fog production Backstoptimer (Smoke Active).
O/C when Active.

12.7.2 Non critical fault output (terminals 9 and 10)

Terminals 9 and 10 are normally closed.

This output is always suppressed when the system is set.

O/C when Active. Low Fluid or Battery fault.

12.7.3 System fault output (terminals 11 and 12)

Terminals 11 and 12 are normally closed. (Default)

The relay opens if a critical fault is present (default)

- LED 2 flashing
- No fluid
- Temperature fault
- Mains failure

13. Setting the activations time

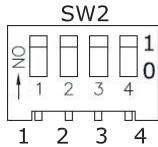

Fog production time

0	0	x	x	15 sec
1	0	x	x	30 sec
0	1	x	x	45 sec
1	1	x	x	60 sec

SmokeCloak Easy interface DIP switch settings

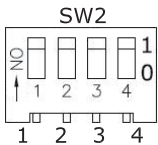

Number of retriggers

x	x	0	0	0
x	x	1	0	2
x	x	0	1	4
x	x	1	1	8

SmokeCloak Easy interface DIP switch settings

14. Preparation for final Test

Before proceeding with any test, it is essential that the local fire brigade, people on site and neighbours are informed of what is going to happen.

Ensure that any fire detection system is put on test or the customer has control of it. SmokeCloak will activate all types of smoke detector. However, it will not activate heat or carbon monoxide detectors.



The supplied SmokeCloak warning signs must be fitted on or near likely points of entry. This is an insurance requirement to warn any person entering the building that SmokeCloak is installed

15. Maintenance

The SmokeCloak EASY machines require an annual maintenance check in order to sustain the correct levels of performance and security.

This requires the following:

- Replace the fluid (do not top the fluid up).
- A test of the system.
- Load test the batteries and replace as necessary. It is recommended that batteries are replaced every 2 years due to the heat inside the machine

Do not attempt to clean the internal components of the SmokeCloak EASY or to clean around the nozzle area –This will be extremely hot. The outer covers may be wiped down to remove dust build up.



16. Timers

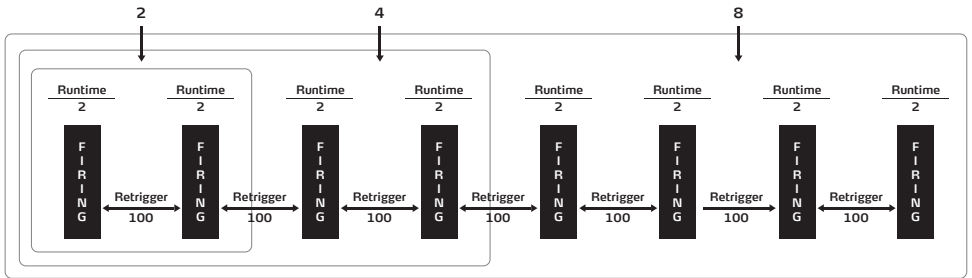

Here the current values are displayed for Retrigger, Backstop and Run timers.

17. Accessories

17.1 Fluid FL600

SmokeCloak FL600 is an exclusive mixture of deionised water and food grade glycols. The formula that has been developed through over 20 years of experience and R&D gives a unique combination of density and hang time.

The SmokeCloak FL600 fluid is very economical in the production of SmokeCloak vapour.

The typical “hang” time in a static air environment is around 45 min and the FL600 fluid creates a uniform sub micron particle size.

Fluid is supplied in a 1 litre container which fits all SmokeCloak EASY machines. The fluid is harmless and a full safety data sheet is available on request.



17.2 LED Strobe

Light protection – as well as fog.

This powerful product from MSS Professional A/S adds an extra dimension to the instant protection from your SmokeCloak system. The LED Strobe is an ultra bright strobe light that gives a blinding effect when used with dense fog coverage. When used together with fog this product offers total instant protection. The LED Strobe is easy to install and will fit into any current alarm installation.

Dimensions: 505 x 140 x 226 mm

Weight: 4.0 kg

Electrical: 100v – 240V nominal

Power 2.7A, 380W @ 240V

Consumption 2.5A, 250W @ 240V



